

DPS 455 Mounting instruction

TAKTON

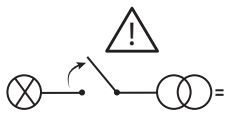

The installation should be carried out by an electrician or by any similarly qualified person.

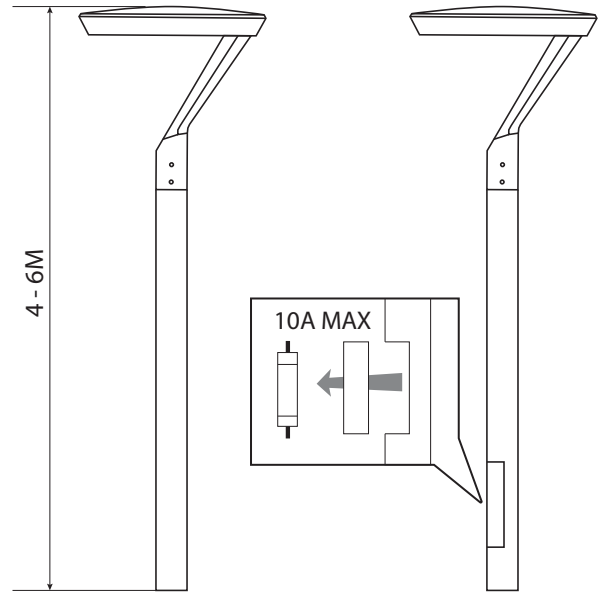
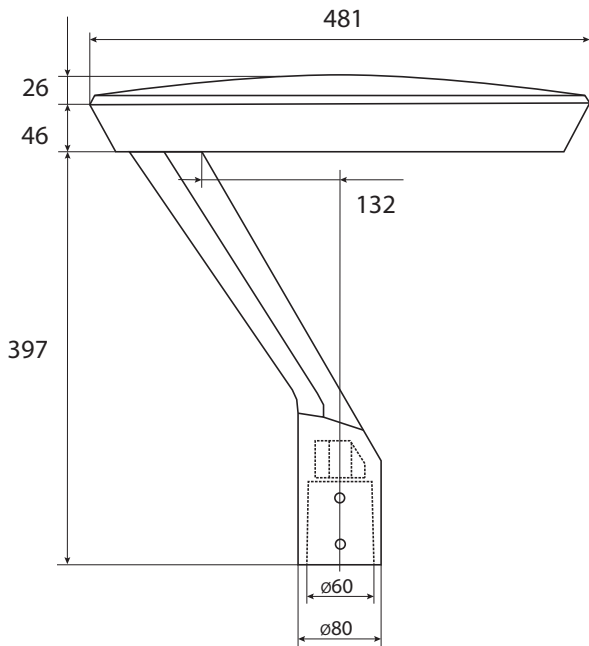

DAN PE LDA

DAN LDA

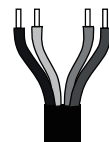
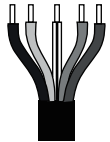

5 X 1.5mm²

4 X 1.5mm²

DA	BLACK
N	BLUE
PE	YELLOW-GREEN
L	BROWN
DA	GREY

